

## L1<sup>®</sup> Midface

Midface Osteosynthesis

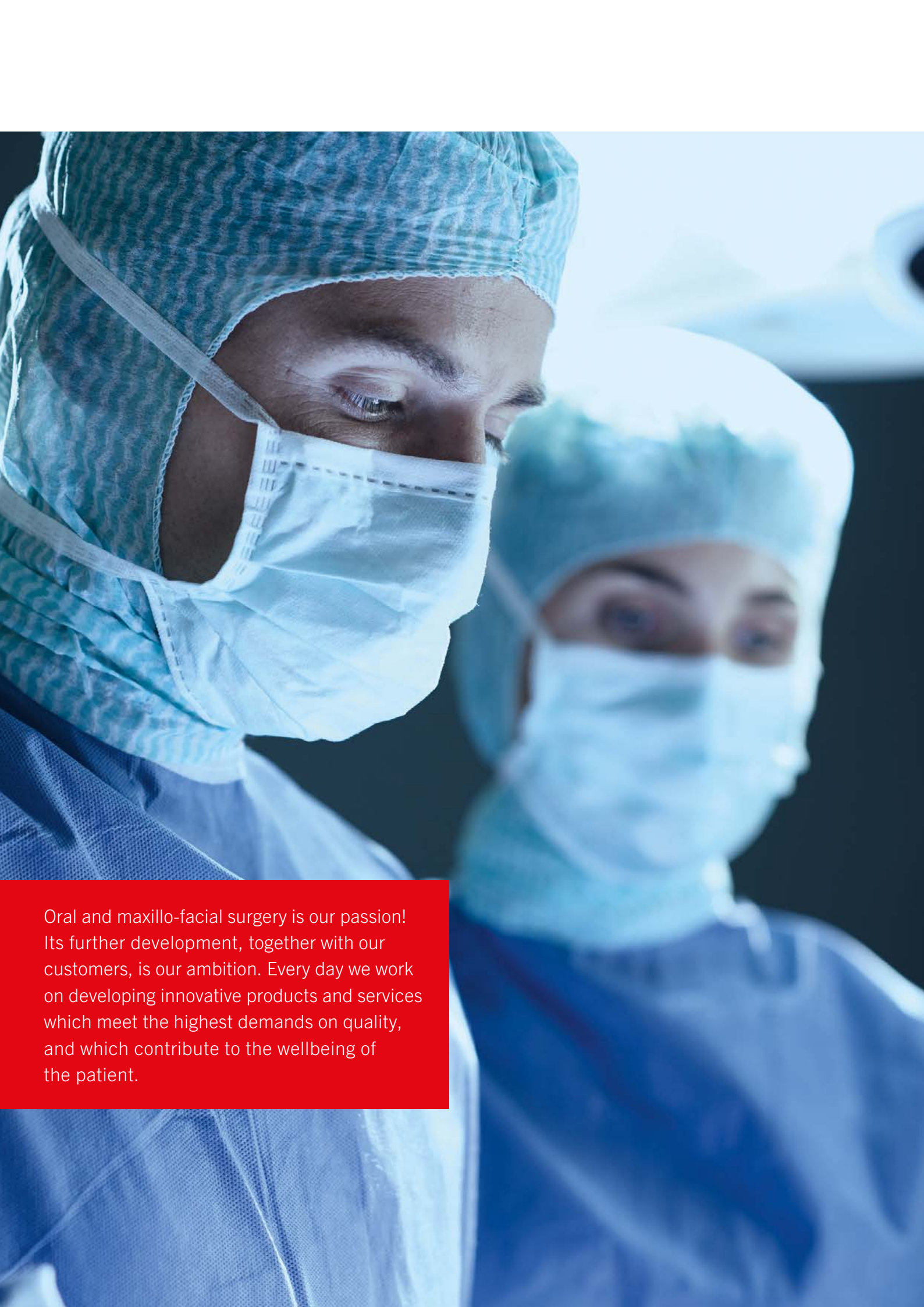

Oral and maxillo-facial surgery is our passion! Its further development, together with our customers, is our ambition. Every day we work on developing innovative products and services which meet the highest demands on quality, and which contribute to the wellbeing of the patient.

## Table of Contents

	Pages
Introduction	4-5
Product Features	6-13
Indications and Surgical Technique	14-29
■ Handling of the Instruments	16-21
■ Complex Midface Fracture	22-29
- Treatment with three 1.5 Midface Plates	
Product Range	30-55
■ Implants	30-41
■ Instruments	42-45
■ Storage	46-55



## L1® Midface

### Midface Osteosynthesis

The complex structures in the midface, consisting of strong bony abutments and thin bone lamellae, provide a stable, three-dimensional frame, but are also susceptible to traumatic events and predisposed to fractures in typical locations.

Restoration of these structures in functional and aesthetic aspects is a demanding task.

L1® Midface is available as a well-structured, yet complete range of plates in three different profile thicknesses, which can be combined with the proven 1.5 mm diameter maxDrive® screws.

In combination with an optimally designed set of instruments and a well thought-out storage concept, this provides the best prerequisites for successful osteosynthesis as well as simple and efficient handling of the system.

## Features, Functions and Benefits



The plate range of the L1® Midface System offers a complete selection of plates in three profile thicknesses and different shapes for midface osteosynthesis.

In addition to proven standard implants in the two configurations 1.5 Micro, the somewhat more delicate line, and 1.5 Midface, consisting of three profile thicknesses, a separate, optional add-on module with three-dimensionally pre-bent Smart3D plates is available, which offer the best possible precision fit.

In combination with the 1.5 mm dia. maxDrive® screws this provides the best conditions for ensuring successful osteosynthesis.

# L1® Midface – Plates

## Features

## Benefits

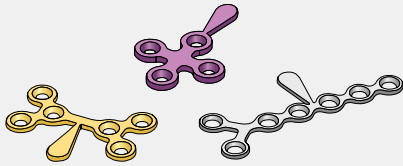

- Color-coded standard implants in the configurations:
  - 1.5 Micro: **Profile 0.6 mm**
  - 1.5 Midface: **Profile 0.6 mm**  
**Profile 0.8 mm**  
**Profile 1.0 mm**

- Maximum choice according to the anatomical situation and fracture to be treated
- Easy recognition and clear identification of the respective profile thickness

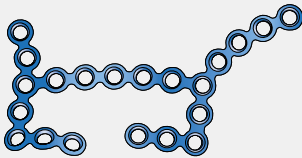

- Three-dimensionally pre-shaped Smart3D implants as an option:
  - 1.5 Smart3D: **Profile 0.6 mm**
- Designed on the basis of average areas

- Supplements the standard implants
- High precision fit
- Option of reduction against the plate



- Detachable ID tag with article number, batch number, GTIN number, and GS1 DataMatrix code

- Enables reading or digital recording of all the relevant data, even in the case of very small implants
- Batch traceability of every single plate
- Simplified reordering

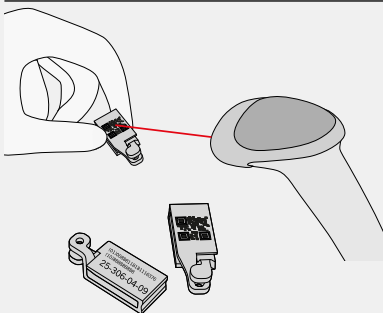

- DataMatrix code for scanning with a two-dimensional barcode scanner

- Easy recording of all the implant data by scanning the DataMatrix code
- 100% batch traceability and transparent, patient-related documentation

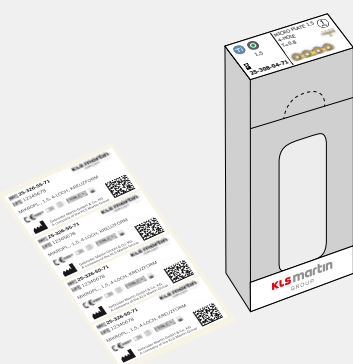

- All plates are also available in individually sterile packaged versions
- Including self-adhesive labels with all the relevant implant data

- Maximum selection options for the user
- 100% batch traceability and transparent, patient-related documentation

## Features, Functions and Benefits

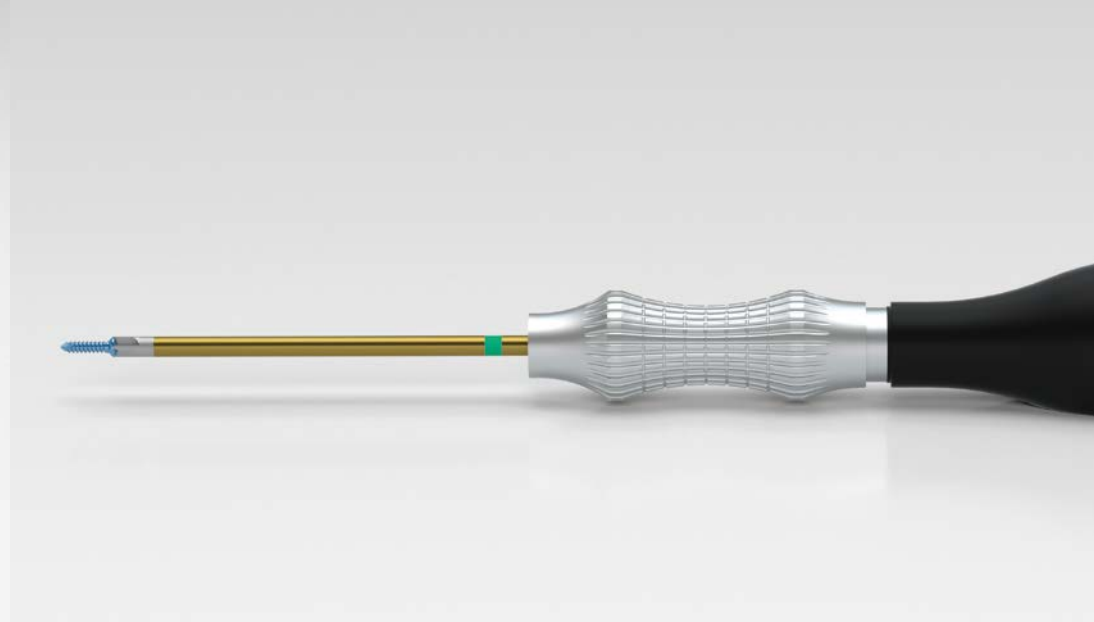

All the plates in the L1® Midface system can be combined with 1.5 mm diameter screws.

maxDrive®, being a high-precision osteosynthesis screw with excellent self-retaining properties, allows easy pick-up, screwing in, and retightening of the screw in combination with direct transmission of force from the screwdriver blade to the screw, even in an angular position.

Clear identification of diameters is ensured with color-coded single clips.

Whether the screws are a standard, emergency or drill-free screw is easy to determine through the corresponding color-coding of the screws, even when stored in the clip.

Color code of the screw	Screw type
Blue:	Standard screw
Pink:	Emergency screw
Silver	Drill-free screw



# L1® Midface – Screws

## Features

## Benefits

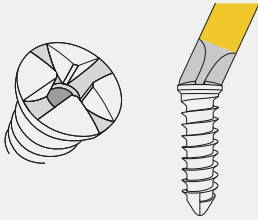

- Proven maxDrive® screws with predefined, self-centering guide and excellent self-retaining mechanism

- Easy finding, pick-up, and tightening of the screw
- Can be screwed in at an angle
- Direct force transfer from the screwdriver blade to the screw

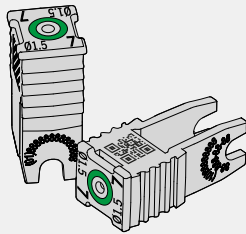

- Screws in color-coded single clip with article number, batch number, GTIN number, and GS1 DataMatrix code

- Clear identification of the respective screw diameter
- Enables reading or digital recording of all the relevant data
- Batch traceability of every single screw

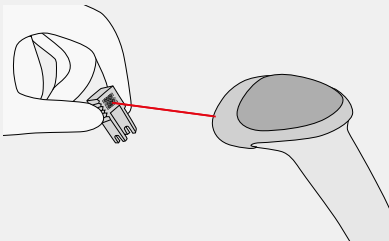

- DataMatrix code for scanning with a two-dimensional barcode scanner

- Easy recording of all the implant data by scanning the DataMatrix code
- 100% batch traceability and transparent, patient-related documentation

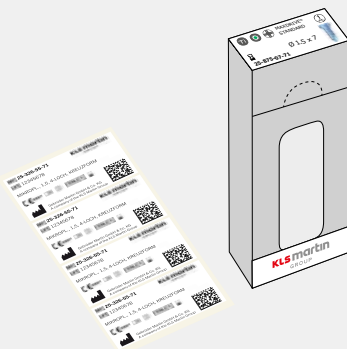

- All screws are also available in individually sterile packaged versions
- Including self-adhesive labels with all the relevant implant data

- Maximum selection options for the user
- 100% batch traceability and transparent, patient-related documentation

## Features, Functions and Benefits



The system-specific instruments are optimally adapted to the implants and designed for best possible efficient handling.

This is reflected not only by ergonomic handles, but also by easy, intuitive usability.

This rounds off the system and thus contributes to maximum user support and successful accomplishment of osteosynthesis.

## L1<sup>®</sup> Midface – Instruments

### Features

### Benefits

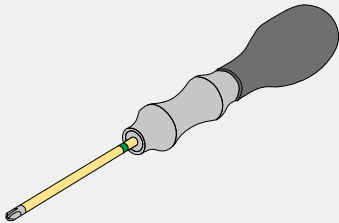

- Screwdriver with flattened silicone handle
- Color-coded screwdriver blade with self-retaining function
  - Gold/green: maxDrive<sup>®</sup> 1.5 mm dia.

- Good, secure grip in the hand, even with wet gloves
- Prevents rolling on the table
- Clear marking and identification of screw diameter
- Direct force transfer from the screwdriver blade to the screw
- Screw is easy to screw in and tighten

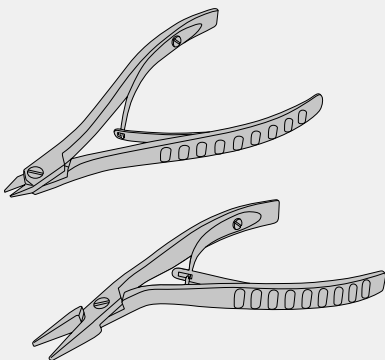

- Bending instruments with uniform, ergonomic handle design, and spring-loaded closure

- Optimal handling and secure hold
- Adjustable, controlled movement
- Standardized handling by design

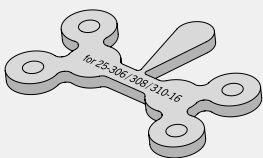

- Reusable sizers available for all plates

- Sizer reflects the plate 1:1 in terms of shape
- Safe selection of the sterile packaged plate

## Features, Functions and Benefits



When redesigning the storage system, it was important for us to build upon the success of the LevelOne storage system, which has proved successful on the market for more than 15 years, to utilize the feedback from our customers, and to implement their needs and today's requirements even better.

For this reason, in addition to efficient handling, for example by the instruments being arranged according to the sequence of use during surgery, the focus was also on the need for traceability and optimized reprocessing capability in order to equally meet the needs of everyone involved.

The new cleaning and sterilization-validated implant modules, which are suitable for machine reprocessing, satisfy these requirements in every respect and, as an open solution with 100% batch traceability for each individual implant, they represent a genuine alternative to the sterile packaged system.

# L1® Midface – Storage

## Features

## Benefits

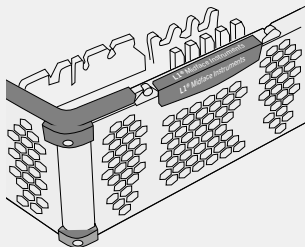

- Stainless steel storage trays in honeycomb design combined with high-performance plastic

- Good rinsing results due to large openings
- Suitable for machine reprocessing

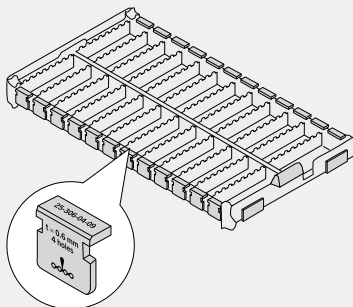

- Each compartment in the plate module is marked with a labeling clip that bears the article number, the plate profile, and a picture of the plate.
- Matt, dark inner surface

- Application-oriented access to the plate and intuitive refilling
- Transparent arrangement
- Increased contrast and good recognition of plates, even under surgical light

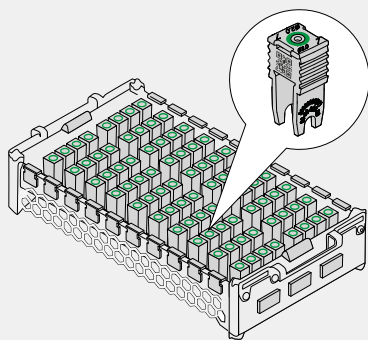

- Single screw clips can be taken out of the screw module from any position

- Easy removal and refilling

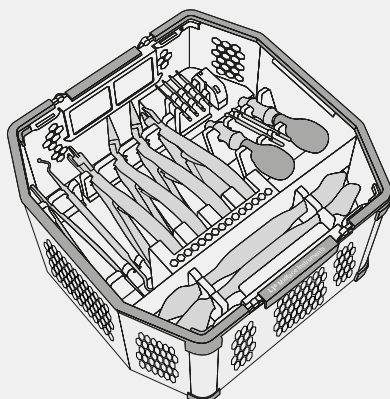

- In the storage tray the instruments are arranged according to the sequence of use during surgery
- Storage areas with laser images and article numbers

- Swift and intuitive supply of instruments during surgery
- User-friendly and efficient passing of instruments to the surgeon
- Transparent arrangement and easy sorting

## Step by Step to Optimal Treatment

### Indications

The L1® Midface system is used in particular for the treatment of fractures, fixation of osteotomies, and within the context of reconstructive procedures in the midface area.

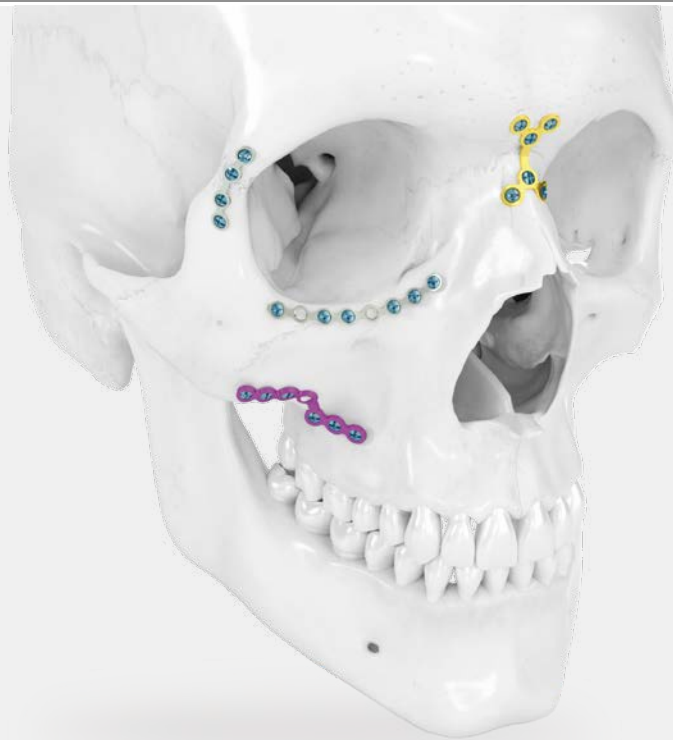

## Surgical Technique

### 1. Handling of the Instruments

Pages 16-21



### 2. Complex Midface Fracture

Pages 22-29

Treatment with three 1.5 Midface plates:

- 4-hole plate, profile 0.6 mm
- Orbital rim plate, profile 0.6 mm
- L-plate, profile 0.8 mm

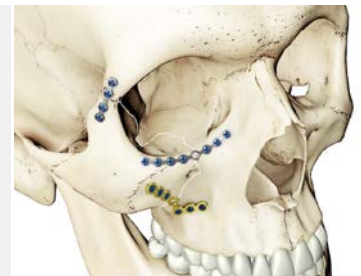

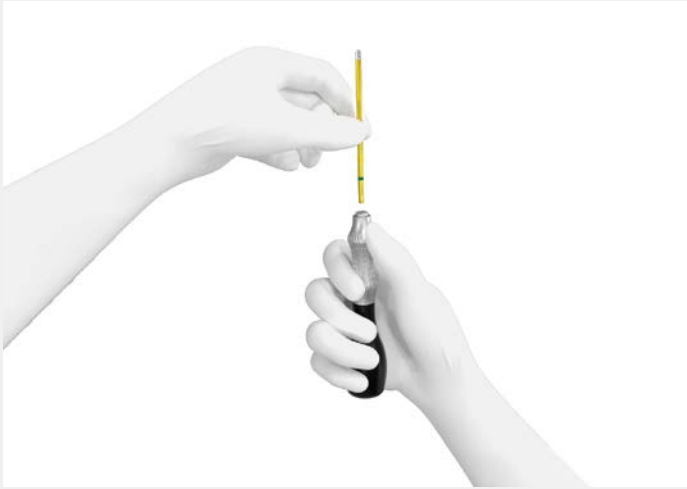

#### **Assembly of the screwdriver**

The screwdriver blade with hex coupling is connected to the screwdriver handle. To do this, the silver-colored, serrated part of the handle is pulled backwards to insert the blade into the holder while maintaining this position. After insertion of the blade, the serrated part is released and returned to its original position, thus ensuring secure anchoring of the blade.

Blades for 1.5 mm dia. screws are marked with a green ring.



#### **Removing the screws from the screw module**

The tip of the screwdriver blade is inserted vertically into the head of the screw and picked up under light axial pressure to ensure a secure grip.



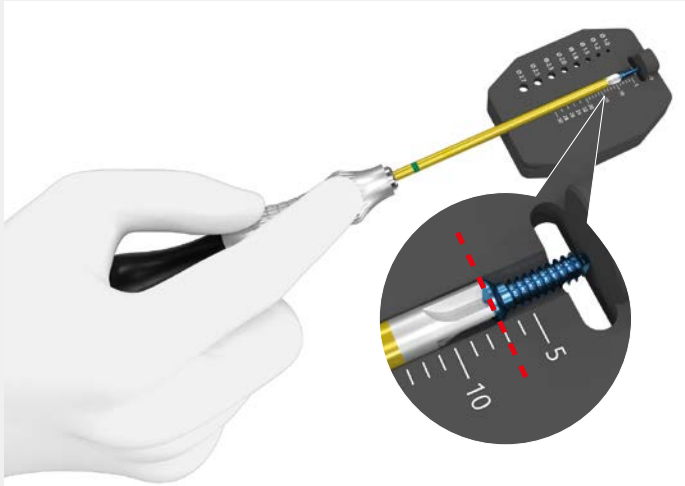

### Checking the screw diameter and screw length

The screw diameter and length can be checked using the screw measurement clip.

#### **Screw length:**

The length is read off at the head end of the screw.

#### **Screw diameter:**

The screw fits exactly into the hole of the corresponding system diameter. It will not fit into the hole of the next smaller diameter.

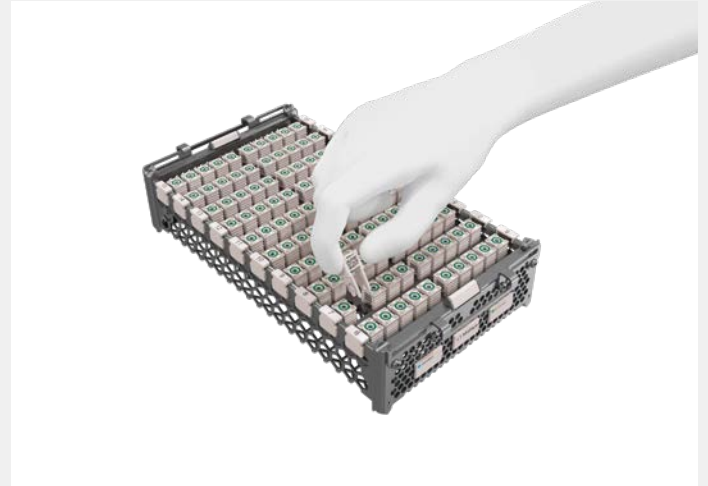

### Removing the single screw clips from the screw module

After use, the empty single screw clips can be taken out of the screw module from any position and refilled accordingly.

The empty clips are collected for later recording of the implant data.





#### Removing the plate from the plate module

The plate is removed from the plate module using forceps.

The ID tag must be removed before implantation. To do this, the ID tag is compressed so that the bracket opens and can be removed accordingly.

The ID tags are collected for later recording of the implant data.

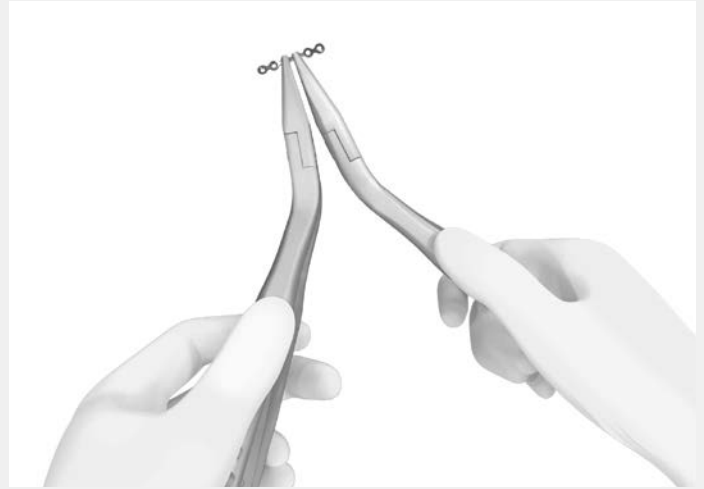

#### Contouring the plate with the plate bending pliers

##### 3D bending in multiple planes

The plate can be adapted using the two bending pliers. To protect the plate holes, make sure that they are completely covered by the pliers and always hold the plate at two consecutive holes, otherwise the contour of an intermediate hole could be damaged.

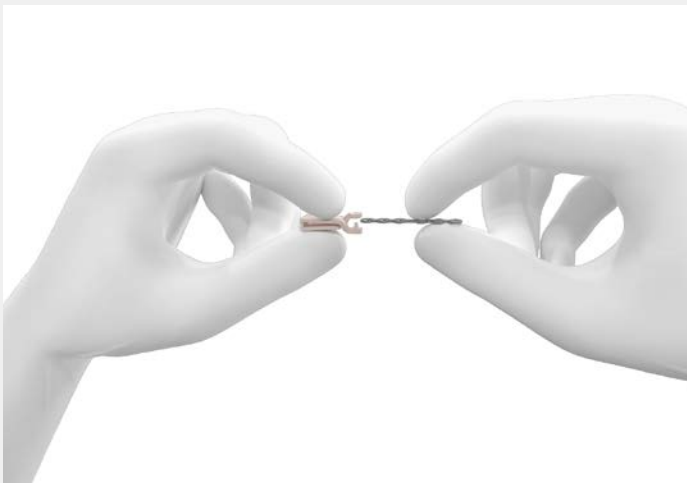



### Contouring the plate with the 3-point bending pliers

#### Bending over edge

The plate is picked up in the area where it is to be bent via the two pins integrated into the instrument. By activating the bending pliers the plate is bent over edge.

#### Bending across the surface

The plate can be bent across the surface in the area of its bars using the 90° bending function. To do this, the plate is placed such that the bar lies between the two pins of the pliers. By activating the bending pliers the plate is bent across the surface.

#### Precautions when contouring:

- If adaptation of the plate is unavoidable, the desired contour must be created with as few bending movements as possible.
- Avoid sharp angles, small bending radii, and frequent bending back and forth as the risk of breaking the plate is increased.
- Do not bend the plate at a screw hole and be careful not to deform the same.





#### Cutting the plate with the cutting pliers

The plate is placed between the cutting surfaces of the cutting pliers in the area where it is to be cut. By activating the cutting pliers, the plate is cut through in the desired area.

#### Precautions

- If cutting of the plate is unavoidable, place your hand loosely around the cutting area during cutting to ensure that all implant particles remain where they are.
- Sharp edges may need to be deburred.



#### Holding the plate in position with the Lindorf plate holding instrument

The plate can be positioned and held securely on the bone with the Lindorf plate holding instrument.

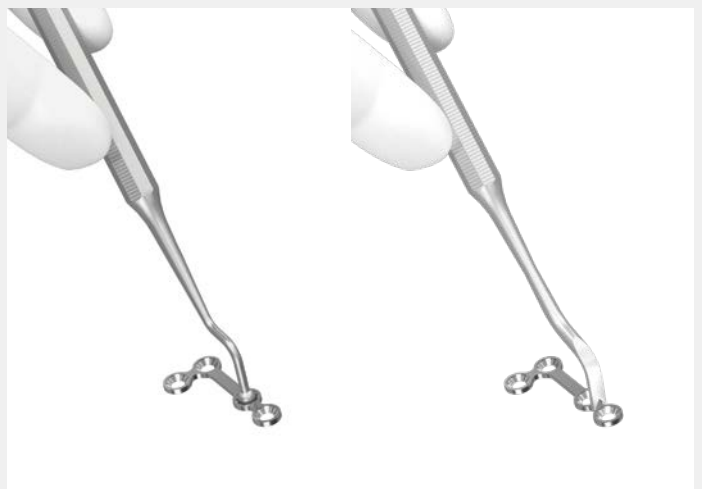



### Scanning the DataMatrix code

The single screw clip as well as the plate ID tag contain all the relevant data in readable plain text as well as encoded in a GS1 DataMatrix code:

- Article number
- Batch number
- GTIN number

This way, the information can either be manually transferred to the patient file and used for reordering, or it can be captured and further processed by scanning the DataMatrix code with a 2D code scanner.

The DataMatrix code can also be read with a smartphone or the "iGepir" app provided by GS1 Germany.

### GTIN number

The GTIN number (Global Trade Item Number) clearly identifies articles worldwide. It acts as an access key to the product information stored in databases, such as, for example, the product designation and weight.

Additionally, variable data are added to the GTIN number using GS1 application identifiers. In the case of KLS Martin, this is the batch number, and for sterile packaged products, the expiry date.

Configuration of the number for sterile packaged implants:

→ (01)123456789111(17)251210(10)12345678

GTIN number	Expiry date (e.g. 10.12.2025)	Batch number
(01)123456789111	(17)251210	(10)12345678
↑	↑	↑

GS1 application identifier, a unique identifier for the respective product information:

- 01 – always initiates the GTIN number
- 17 – always initiates the expiry date
- 10 – always initiates the batch number



### Preoperative planning

The x-ray image shows a complex right-sided multi-fragmented zygomatic fracture:

- ① Fracture of the zygomatic arch
- ② Fracture of the lateral orbital rim
- ③ Fractures of the inferior orbital rim as well as the anterior and posterior maxillary sinus walls

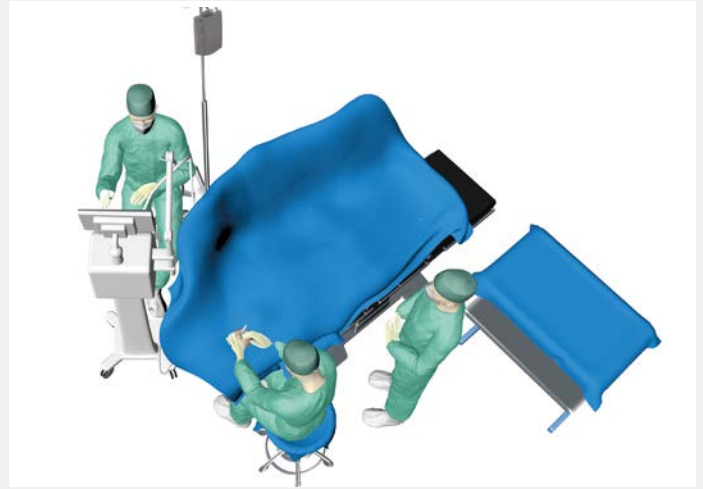

### Patient positioning

The patient is placed in the supine position on the operating table. Normally, a nasotracheal intubation is implemented.

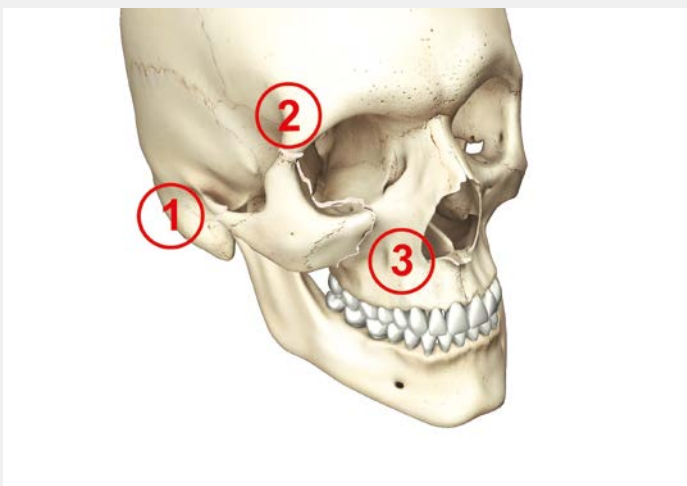

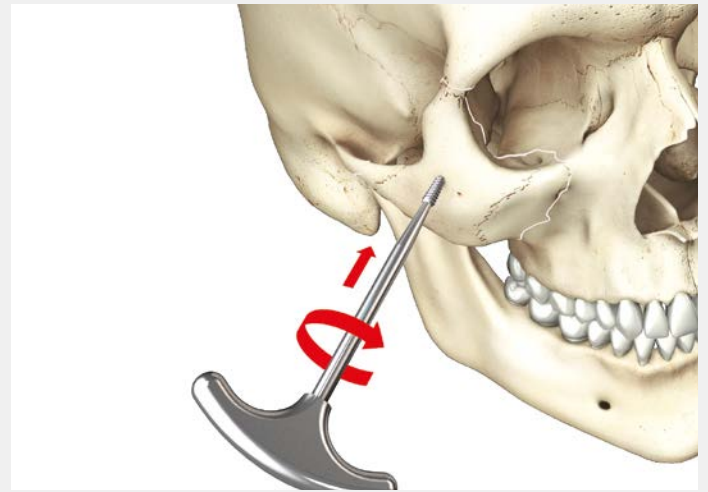

## 1. Approach and reduction of the zygomatic bone

The first step is reduction of the zygomatic bone to its correct anatomical position. Reduction can be performed in different ways.

### Option 1

Reduction with a retractor inserted transorally through the vestibular access to the maxillary sinus.

### Option 2

A threaded reduction tool can be used for zygoma reduction inserted percutaneously into the zygoma.

The surgeon can either work with the Byrd T handle 38-709-03-07, or with the Byrd zygomatic reduction screw which is used with the screwdriver handle 25-407-04-04.

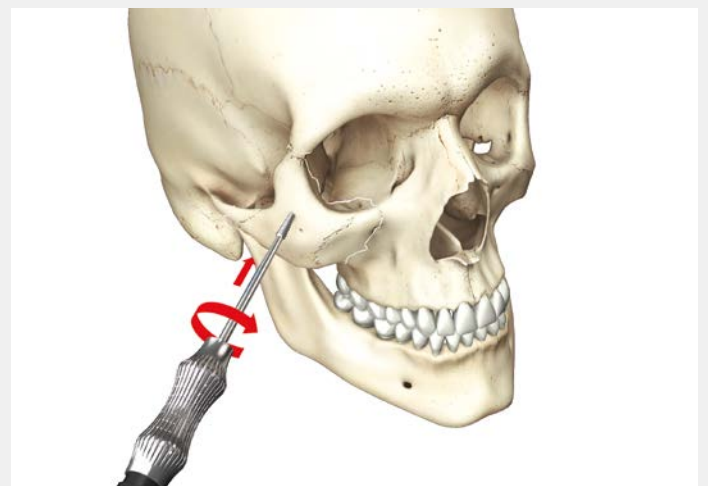
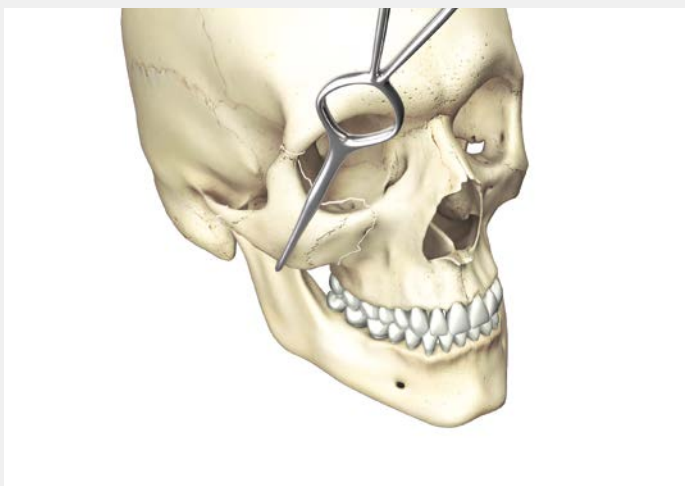

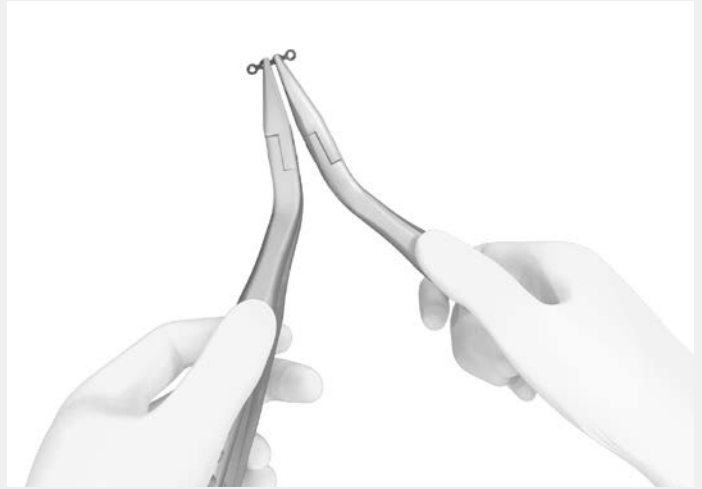
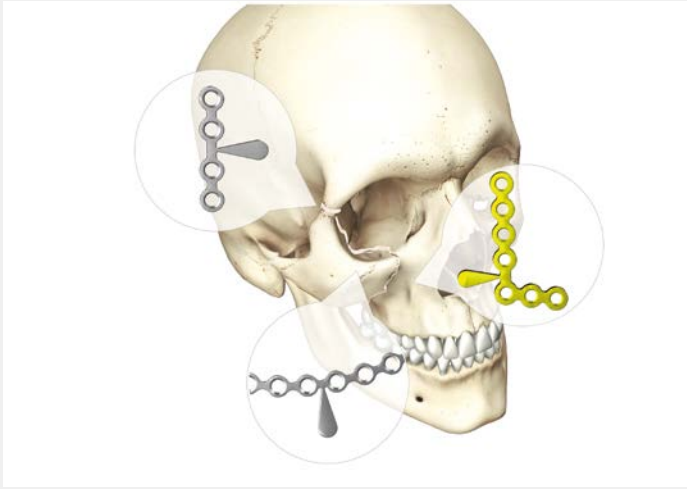

## 2. Selection of osteosynthesis plates

After exact reduction, a three-point fixation of the fracture is performed. In the present indication case, the following plates are used for the treatment by way of example:

- a Fracture of the zygomatic arch
  - **No plate**
- b Fracture of the lateral orbital rim
  - **4-hole plate with bar (t=0.6 mm, 25-306-05-09)**
- c Fractures of the inferior orbital rim as well as anterior and posterior maxillary sinus walls
  - **Orbital rim plate bent (t=0.6 mm, 25-306-32-09)**
  - **L-plate (t=0.8 mm, 25-308-07-09)**

However, the choice of osteosynthesis plates in terms of shape and thickness always depends on the course of the fracture and the patient's anatomy. We recommend using low plate profiles in the area of the lateral and lower orbital rim. A plate with a thicker profile is recommended in the area of the maxillary abutment.

### Use of sterile packaged implants:

When using sterile packaged implants, sizers can be used that reflect the respective shape of the plate 1:1, thus enabling safe selection of the sterile packaged plate.

## 3. Adapting the plate for the lateral orbital rim

If necessary, the osteosynthesis plate is adapted to the anatomical situation using the two bending pliers 25-516-14-07 and/or the 3-point bending pliers 25-417-16-07.

A detailed description of the instruments and corresponding procedures can be found on pages 16-21.

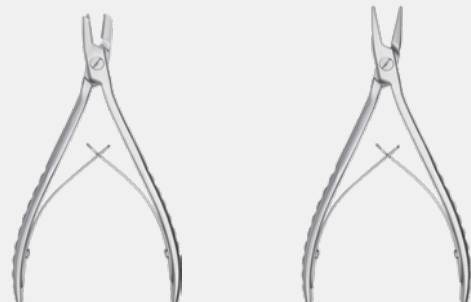

3-point bending pliers

Bending pliers, curved





#### 4. Positioning the plate for the lateral orbital rim

The plate for the lateral orbital rim is inserted via an approach in the lateral eyebrow and placed over the fracture area.

The plate can be temporarily held in position with the plate holding instrument.



#### 5. Drilling the first core hole for fixation of the plate for the lateral orbital rim

First the core hole is drilled with the corresponding drill bit. Drill bits for 1.5 mm dia. screws have a core hole diameter of 1.1 mm and are identified by a **green** ring.

Ensure that a suitable stop length is selected.

*Note: Drill-free screws are also available, which can be screwed into the bone without prior drilling.*



Plate holding instrument

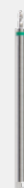

Drill bits for screws,  
1.5 mm dia.

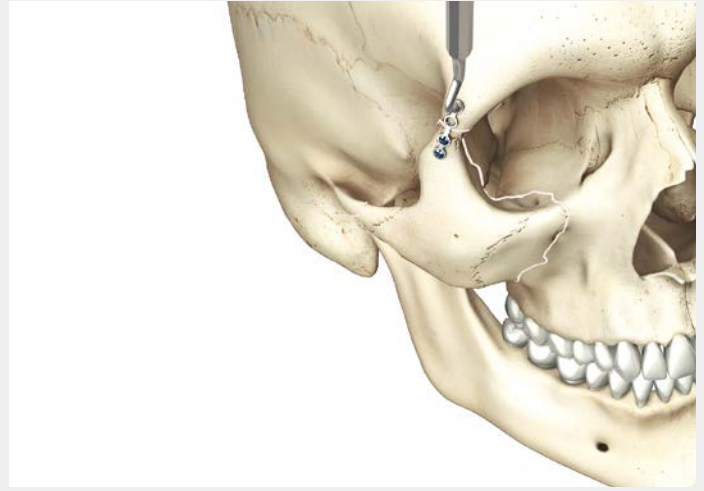
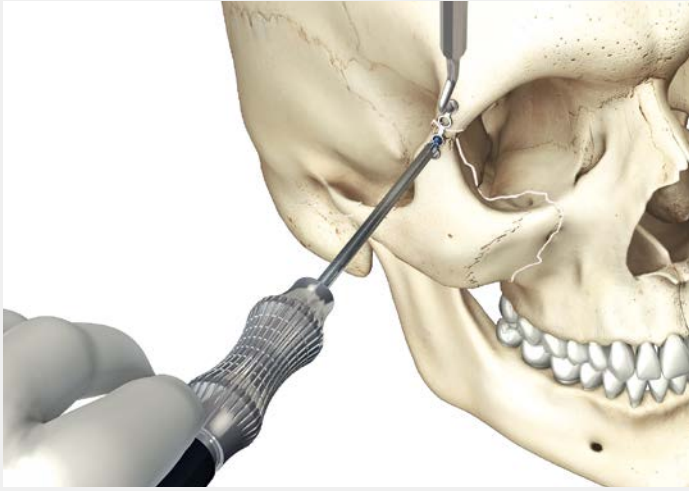

**6. Fixation of the plate for the lateral orbital rim – inserting the first screw**

The first maxDrive® standard screw is inserted into the unstable fragment of the zygomatic fracture. To do this, the screw is picked up with the screwdriver, screwed in, and securely fixed. Before fixation, check the screw length using the screw measurement clip.

**7. Fixation of the plate for the lateral orbital rim – inserting the second screw**

The second screw is also inserted in the same way into the unstable fragment of the zygomatic fracture in order to keep the plate in the correct position.



Screwdriver handle



maxDrive® blade



Screw measurement clip



Drill bit



Screwdriver handle



maxDrive® blade



Screw measurement clip

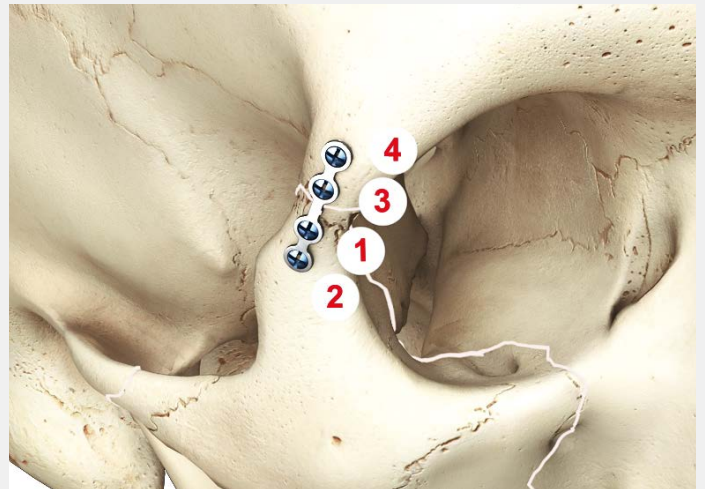
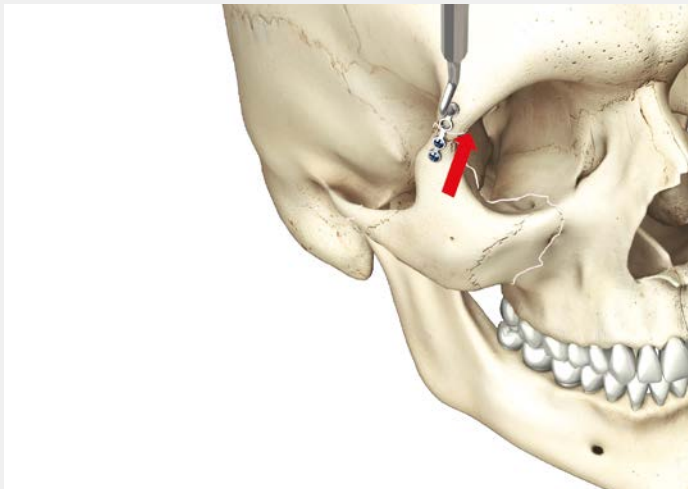

### 8. Zygomatic reduction and insertion of further screws

After reduction of the zygomatic fragment in a cranial direction the plate holding instrument is fixated in its position while inserting further screws.



Plate holding instrument

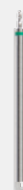

Drill bit



Screwdriver handle



maxDrive® blade



Screw measurement clip

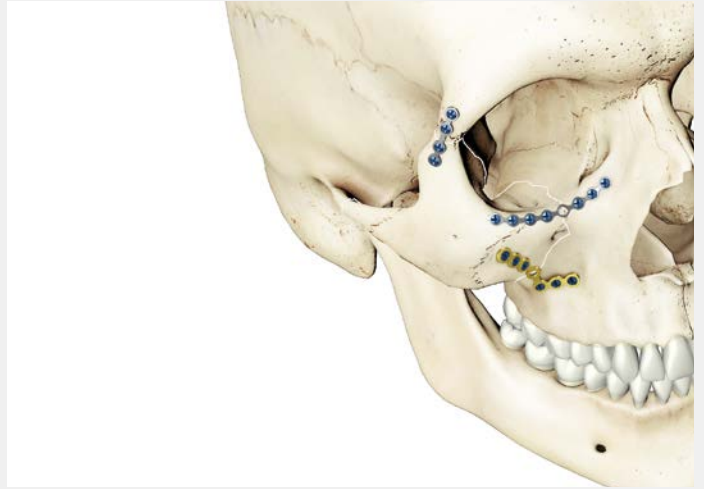
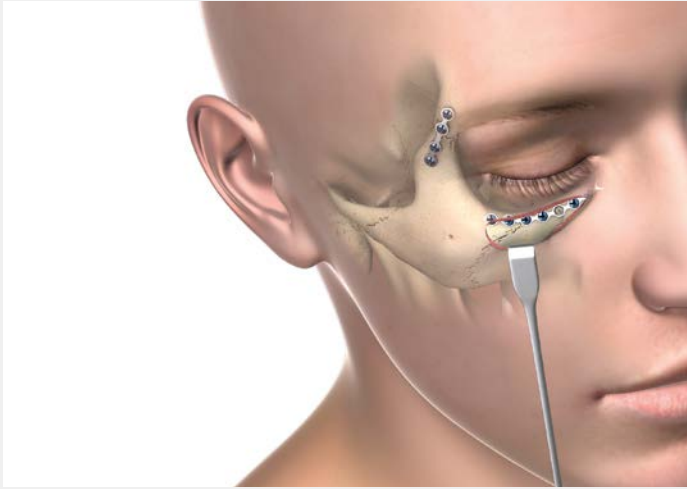

### 9. Fixation of the plate for the infraorbital rim

The plate for the infraorbital rim is inserted through an approach in the lower eyelid. Here it is important to ensure that the lateral sinus wall has been correctly reduced prior to positioning the plate.

If necessary, the bent orbital rim plate is adapted to the anatomical situation using the two bending pliers 25-516-14-07 and/or the 3-point bending pliers 25-417-16-07.

The screws are inserted following the procedure described in steps 5 and 6, starting with the unstable fragment area.

### 10. Fixation of the zygomaticomaxillary support plate

The L-plate is inserted through a maxillary vestibular approach.

If necessary, the osteosynthesis plate is adapted to the anatomical situation using the two bending pliers 25-516-14-07 and/or the 3-point bending pliers 25-417-16-07. The vertical portion must be adapted to the most lateral portion of the zygomatic process, where the bone is still thick enough for safe insertion and anchorage of a screw.

The horizontal portion of the plate is placed along the alveolar bone. The dental roots must not be harmed.

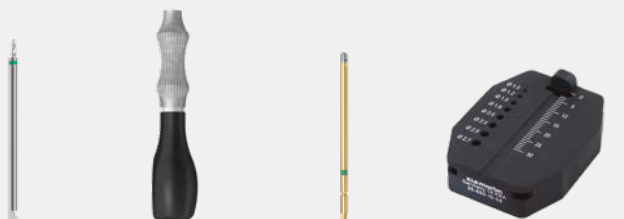

Drill bit      Screwdriver handle      maxDrive® blade      Screw measurement clip

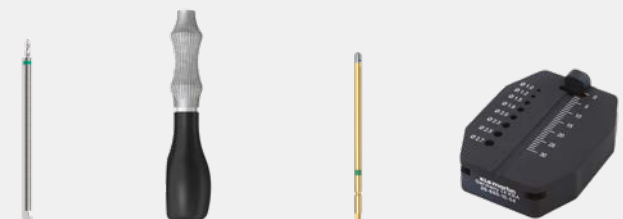

Drill bit      Screwdriver handle      maxDrive® blade      Screw measurement clip



### 11. Wound closure

When all the plates have been inserted successfully, the wound is closed.



### Follow-up treatment

The x-ray shows the postoperative findings.

## Implants L1® Midface – Configuration 1.5 Midface Plates in profile thickness 0.6 mm



25-306-04-09 Ti 1

25-306-04-71 Ti 1

⌀ = 0.6 mm

25-310-04-88 Ti 1



25-306-05-09 Ti 1

25-306-05-71 Ti 1

⌀ = 0.6 mm

25-310-05-88 Ti 1



25-306-06-09 Ti 1

25-306-06-71 Ti 1

⌀ = 0.6 mm

25-310-06-88 Ti 1

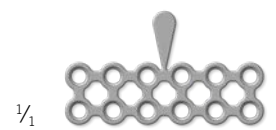

25-306-22-09 Ti 1

25-306-22-71 Ti 1

⌀ = 0.6 mm

25-310-22-88 Ti 1



25-306-24-09 Ti 1

25-306-24-71 Ti 1

⌀ = 0.6 mm

25-310-24-88 Ti 1



25-306-18-09 Ti 1

25-306-18-71 Ti 1

⌀ = 0.6 mm

25-310-18-88 Ti 1



25-306-17-09 Ti 1

25-306-17-71 Ti 1

⌀ = 0.6 mm

25-310-17-88 Ti 1



25-306-16-09 Ti 1

25-306-16-71 Ti 1

⌀ = 0.6 mm

25-310-16-88 Ti 1

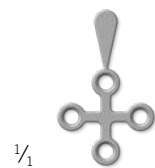

25-306-14-09 Ti 1

25-306-14-71 Ti 1

⌀ = 0.6 mm

25-310-14-88 Ti 1



Explanation of icons

- Pure titanium
- Units per package
- Plate profile

**STERILE IR** Sterile packaged implants

Sizer

$\frac{1}{1}$

25-306-07-09   
 25-306-07-71   
 = 0.6 mm

25-310-07-88

$\frac{1}{1}$

25-306-09-09   
 25-306-09-71   
 = 0.6 mm

25-310-09-88

$\frac{1}{1}$

25-306-32-09   
 25-306-32-71   
 = 0.6 mm

25-310-32-88

Optional

$\frac{1}{1}$

25-043-01-71   
 = 0.3 mm

## Implants L1® Midface – Configuration 1.5 Midface Plates in profile thickness 0.8 mm



25-308-04-09 Ti 1

25-308-04-71 Ti 1

⌀ = 0.8 mm

25-310-04-88 Ti 1



25-308-05-09 Ti 1

25-308-05-71 Ti 1

⌀ = 0.8 mm

25-310-05-88 Ti 1



25-308-06-09 Ti 1

25-308-06-71 Ti 1

⌀ = 0.8 mm

25-310-06-88 Ti 1

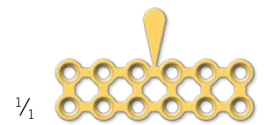

25-308-22-09 Ti 1

25-308-22-71 Ti 1

⌀ = 0.8 mm

25-310-22-88 Ti 1



25-308-24-09 Ti 1

25-308-24-71 Ti 1

⌀ = 0.8 mm

25-310-24-88 Ti 1



25-308-18-09 Ti 1

25-308-18-71 Ti 1

⌀ = 0.8 mm

25-310-18-88 Ti 1



25-308-17-09 Ti 1

25-308-17-71 Ti 1

⌀ = 0.8 mm

25-310-17-88 Ti 1



25-308-16-09 Ti 1

25-308-16-71 Ti 1

⌀ = 0.8 mm

25-310-16-88 Ti 1

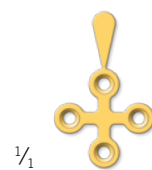

25-308-14-09 Ti 1

25-308-14-71 Ti 1

⌀ = 0.8 mm

25-310-14-88 Ti 1





Explanation of icons

- Pure titanium
- Units per package
- Plate profile

**STERILE IR** Sterile packaged implants

Sizer

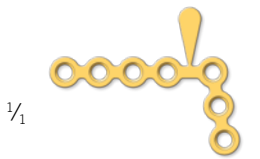

25-308-07-09

25-308-07-71

= 0.8 mm

25-310-07-88

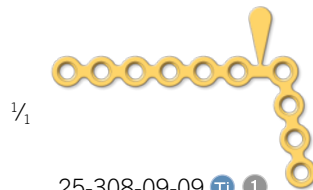

25-308-09-09

25-308-09-71

= 0.8 mm

25-310-09-88

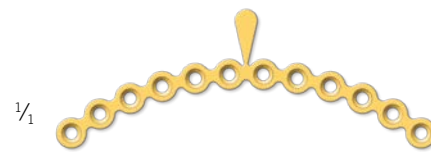

25-308-32-09

25-308-32-71

= 0.8 mm

25-310-32-88

Optional



25-043-02-71

= 0.5 mm

## Implants L1® Midface – Configuration 1.5 Midface Plates in profile thickness 1.0 mm



25-310-04-09 Ti 1

25-310-04-71 Ti 1

☉ = 1.0 mm

25-310-04-88 Ti 1



25-310-05-09 Ti 1

25-310-05-71 Ti 1

☉ = 1.0 mm

25-310-05-88 Ti 1



25-310-06-09 Ti 1

25-310-06-71 Ti 1

☉ = 1.0 mm

25-310-06-88 Ti 1

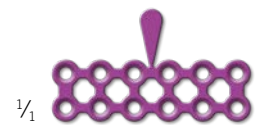

25-310-22-09 Ti 1

25-310-22-71 Ti 1

☉ = 1.0 mm

25-310-22-88 Ti 1



25-310-24-09 Ti 1

25-310-24-71 Ti 1

☉ = 1.0 mm

25-310-24-88 Ti 1



25-310-18-09 Ti 1

25-310-18-71 Ti 1

☉ = 1.0 mm

25-310-18-88 Ti 1



25-310-17-09 Ti 1

25-310-17-71 Ti 1

☉ = 1.0 mm

25-310-17-88 Ti 1



25-310-16-09 Ti 1

25-310-16-71 Ti 1

☉ = 1.0 mm

25-310-16-88 Ti 1

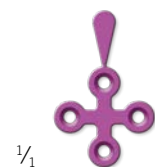

25-310-14-09 Ti 1



25-310-14-71 Ti 1

☉ = 1.0 mm

25-310-14-88 Ti 1





Explanation of icons

-  Pure titanium
-  Units per package
-  Plate profile

**STERILE IR** Sterile packaged implants

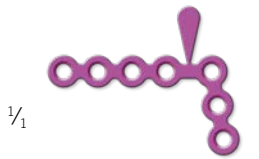

 Sizer





25-310-07-09  



25-310-07-71  

 = 1.0 mm



25-310-07-88  





25-310-09-09  



25-310-09-71  

 = 1.0 mm



25-310-09-88  



25-310-32-09  

25-310-32-71  

 = 1.0 mm

25-310-32-88  

## Implants L1® Midface – Configuration 1.5 Micro Plates in profile thickness 0.6 mm



25-304-00-91 Ti 1

25-304-00-71 Ti 1

= 0.6 mm

25-304-00-88 Ti 1



25-304-55-91 Ti 1

25-304-55-71 Ti 1

= 0.6 mm

25-304-55-88 Ti 1



25-304-70-91 Ti 1

25-304-70-71 Ti 1

= 0.6 mm

25-304-70-88 Ti 1



25-306-00-91 Ti 1

25-306-00-71 Ti 1

= 0.6 mm

25-306-00-88 Ti 1



25-306-55-91 Ti 1

25-306-55-71 Ti 1

= 0.6 mm

25-306-55-88 Ti 1



25-316-00-91 Ti 1

25-316-00-71 Ti 1

= 0.6 mm

25-316-00-88 Ti 1



25-330-07-09 Ti 1

25-330-07-71 Ti 1

= 0.6 mm

25-330-07-88 Ti 1



25-320-70-91 Ti 1

25-320-70-71 Ti 1

= 0.6 mm

25-320-70-88 Ti 1



25-322-70-91 Ti 1



25-322-70-71 Ti 1

= 0.6 mm

25-322-70-88 Ti 1





Explanation of icons

-  Pure titanium
-  Units per package
-  Plate profile

**STERILE | R** Sterile packaged implants



 Sizer





25-310-70-91  



25-310-70-71  

 = 0.6 mm



25-310-70-88  





25-311-70-91  



25-311-70-71  

 = 0.6 mm



25-311-70-88  





25-310-85-91  



25-310-85-71  

 = 0.6 mm

25-310-85-88  





25-311-85-91  



25-311-85-71  

 = 0.6 mm



25-311-85-88  



25-325-10-91  

25-325-10-71  

 = 0.6 mm

25-325-10-88  

## Implants L1® Midface – Configuration 1.5 Smart3D Plates in profile thickness 0.6 mm

### Optional implants

#### Smart3D

#### Zygoma plates

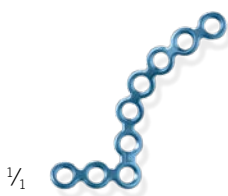

Left

25-320-28-09 Ti 1

25-320-28-71 Ti 1

⌀ = 0.6 mm

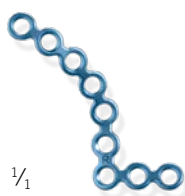

Right

25-320-29-09 Ti 1

25-320-29-71 Ti 1

⌀ = 0.6 mm

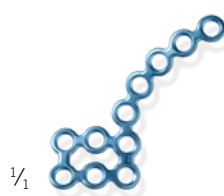

Left

25-320-30-09 Ti 1

25-320-30-71 Ti 1

⌀ = 0.6 mm

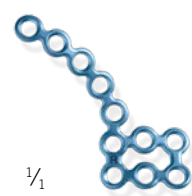

Right

25-320-31-09 Ti 1

25-320-31-71 Ti 1

⌀ = 0.6 mm

#### Paranasal plates

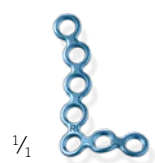

Left

25-320-32-09 Ti 1

25-320-32-71 Ti 1

⌀ = 0.6 mm

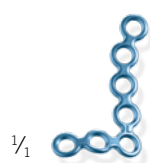

Right

25-320-33-09 Ti 1

25-320-33-71 Ti 1

⌀ = 0.6 mm

#### Zygoma-paranasal plates

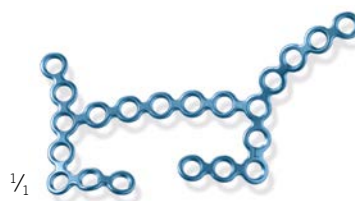

Left

25-320-34-09 Ti 1

25-320-34-71 Ti 1

⌀ = 0.6 mm

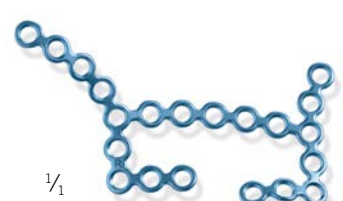

Right



25-320-35-09 Ti 1

25-320-35-71 Ti 1

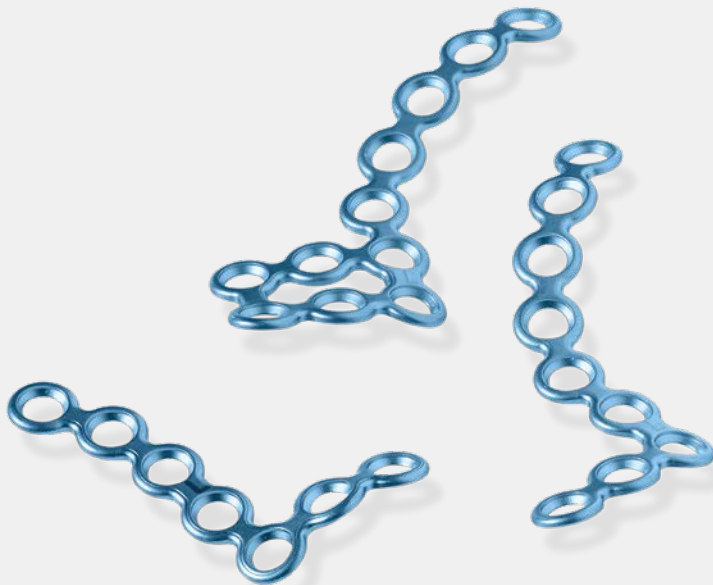
⌀ = 0.6 mm



Explanation of icons

-  Pure titanium
-  Units per package
-  Plate profile



**STERILE | R** Sterile packaged implants

 Sizer

## Optional implants



### Smart orbital floor plates, 3D pre-bent, groove



25-044-32-71  

 = 0.4 mm



Right

25-044-33-71  

 = 0.4 mm



### Smart orbital floor plates, 3D pre-bent, grid, size S



25-045-35-71  

 = 0.5 mm



Right

25-045-36-71  

 = 0.5 mm



### Smart orbital floor plates, 3D pre-bent, grid, size L



25-045-40-71  

 = 0.5 mm

Right

25-045-41-71  

 = 0.5 mm

## Implants L1® Midface maxDrive® screws in single clips

maxDrive® 

### Standard screws 1.5 mm dia.

Self-retaining



Dia. x length	Non-sterile	STERILE   R
1.5 x 3.5 mm	25-875-03-61	25-875-03-71
1.5 x 4 mm	25-875-04-61 *	25-875-04-71
1.5 x 5 mm	25-875-05-61 *	25-875-05-71
1.5 x 6 mm	25-875-06-61	25-875-06-71
1.5 x 7 mm	25-875-07-61 *	25-875-07-71
1.5 x 8 mm	25-875-08-61	25-875-08-71
1.5 x 9 mm	25-875-09-61 *	25-875-09-71
1.5 x 11 mm	25-875-11-61	25-875-11-71
1.5 x 13 mm	25-875-13-61	25-875-13-71
1.5 x 15 mm	25-875-15-61	25-875-15-71

### Emergency screws 1.8 mm dia.

Self-retaining



Dia. x length	Non-sterile	STERILE   R
1.8 x 3.5 mm	25-876-03-61	25-876-03-71
1.8 x 4 mm	25-876-04-61 *	
1.8 x 5 mm	25-876-05-61 *	25-876-05-71
1.8 x 7 mm	25-876-07-61 *	25-876-07-71

### Drill-free screws 1.5 mm dia.

Self-retaining, self-tapping



Dia. x length	Non-sterile	STERILE   R
1.5 x 3.5 mm	25-878-03-61	25-878-03-71
1.5 x 4 mm	25-878-04-61 *	25-878-04-71
1.5 x 5 mm	25-878-05-61 *	25-878-05-71
1.5 x 6 mm	25-878-06-61	25-878-06-71
1.5 x 7 mm	25-878-07-61 *	25-878-07-71

**Note:**

The screws and drills denoted with \* are provided as standard in the L1® Midface storage configuration.



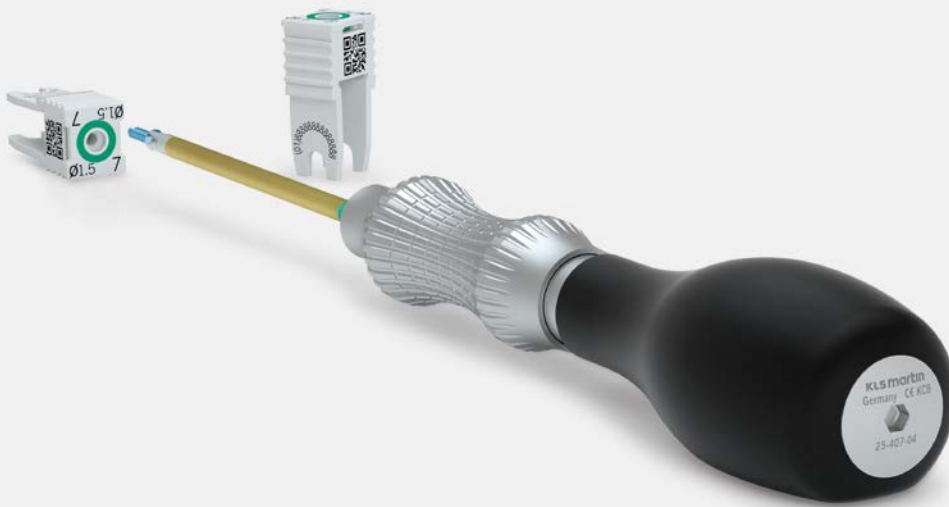

Explanation of icons

- Titanium alloy
- Steel
- J-coupling
- maxDrive®
- System diameter 1.5 mm
- Units per package

**STERILE | R** Sterile packaged implants

Drill bit

for 1.5 mm dia. screws					
J-coupling					
	Dia. x length	Stop	Non-sterile		STERILE   R
			1	5	1
	1.1 x 50 mm	–	25-452-00-91 *	25-452-00-07	25-452-00-71
	1.1 x 50 mm	3.5 mm	25-452-03-91 *	25-452-03-07	
	1.1 x 50 mm	5 mm	25-452-05-91 *	25-452-05-07	25-452-05-71
	1.1 x 50 mm	7 mm	25-452-07-91 *	25-452-07-07	25-452-07-71
	1.1 x 50 mm	9 mm	25-452-09-91	25-452-09-07	25-452-09-71
	1.1 x 50 mm	15 mm	25-452-15-91	25-452-15-07	25-452-15-71
	1.1 x 105 mm	21 mm	25-452-61-07		25-452-61-71

## Instruments **L1**® Midface Standard Instrumentation

### Standard Instrumentation



½

51-525-80-07  
15.5 cm / 6 ⅞"  
Plate holding forceps

St 1

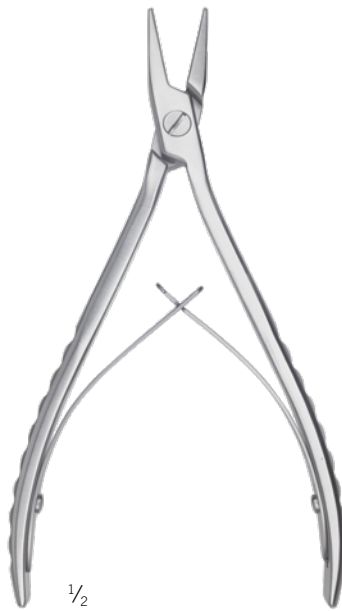

½

25-516-14-07  
15.5 cm / 6 ⅞"  
Bending pliers, curved  
(2 per set necessary)

St 1

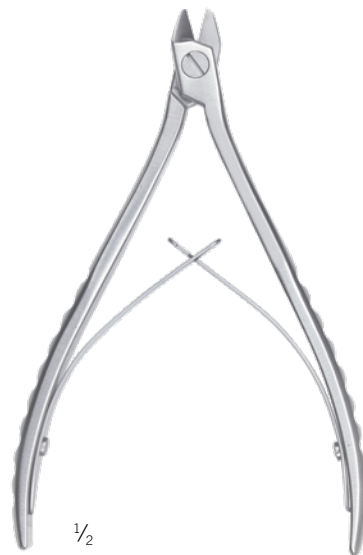

½

25-050-14-07  
14.5 cm / 5 ⅞"  
Cutting pliers,  
up to 1.0 mm profile

St 1



Explanation of icons

- Steel
- Silicone
- maxDrive®
- System diameter 1.5 mm
- Units per package



1/2

25-407-04-04  
11 cm / 4 3/8"  
Screwdriver handle,  
flat, rotatable



1/2

25-438-97-07  
8 cm / 3 1/8"  
maxDrive® blade  
1.5 mm dia.



1/2

25-650-10-04  
5 cm / 2"  
Screw measurement clip,  
length and diameter



1/2

38-695-21-07  
20 cm / 7 7/8"  
Orbital retractor,  
left



1/2

38-696-21-07  
20 cm / 7 7/8"  
Orbital retractor,  
right

## Instruments **L1**® Midface Standard Instrumentation

Standard instrumentation - to be selected according to the corresponding plate configuration

### Option 1

Plate configuration 1.5 Midface

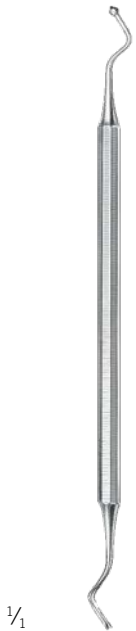

1/1

25-435-55-07

16.5 cm / 6 5/8"

Plate holding instrument

1.5 Midface

St 1

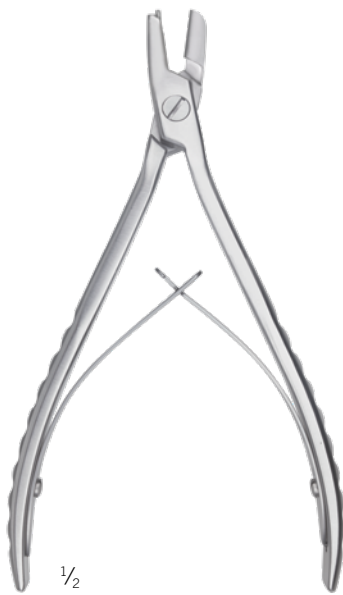

1/2

25-417-16-07

15.5 cm / 6 1/8"

3-point bending pliers

1.5 Midface

St 1

### Option 2

Plate configuration 1.5 Micro

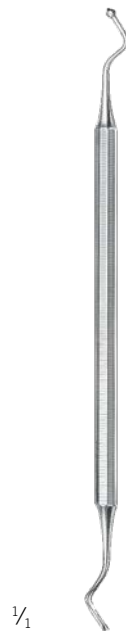

1/1

25-435-15-07

16.5 cm / 6 5/8"

Plate holding instrument

1.5 Micro

St 1

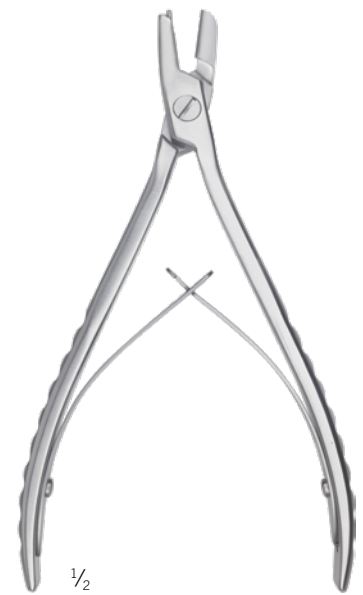

1/2

25-416-14-07

15.5 cm / 6 1/8"

3-point bending pliers

1.5 Micro

St 1



Explanation of icons

- Steel
- maxDrive®
- System diameter 1.5 mm
- Units per package

Optional instruments



38-709-03-07  
Zygoma reduction screw  
with handle



25-438-35-07  
Zygoma reduction screw  
for handle 25-407-04-04



25-438-98-07  
Dispensing sleeve for  
maxDrive® blade 25-438-97-07



25-480-15-07  
maxDrive® blade 1.5 mm dia.  
with retaining sleeve

## Storage L1® Midface – the concept for non-sterile packaged Implants



The screw and plate modules are stored in the implant storage container.

The container offers space for:

- 1 x 1/3 screw module
- 1 x 2/3 screw module
- 2 x 2/3 plate module

Optional space:

- 2 x 1/3 plate module (for Smart3D plates)

For transparent organization and easy identification all the module fronts have color-coded labeling clips that clearly indicate the contents.



Screw modules allow direct, application-oriented access to the screws. After surgery the empty single clips can be taken out of the module from any position.

To meet the requirements of any particular user, two sizes of screw modules are available, which can be configured with various numbers of screw clips.

The small 1/3 module can hold a total of 40 screws stored in a single clip and is therefore ideal for storing special screws. The larger 2/3 module offers space for a total of 100 screws.

Due to labeling with article number, batch number, and GTIN number, all the relevant implant data are provided on the single clip. The printed DataMatrix code also enables easy recording with a scanner system and further processing of data. That means all the conditions are fulfilled for ensuring transparent, patient-related and seamless documentation, as well as for reordering.



In the plate module the plates are clearly arranged and kept separate from each other. Each plate compartment is marked at the side with a labeling clip that bears the article number, the profile, and a picture of the plate. As a result, the necessary information is provided for application-oriented access and intuitive refilling.

The matt inner surface of the module increases the contrast and allows comfortable, dazzle-free work under the surgical light.

The stackable modules, which are available in coordinated sizes, can also be used individually, without a storage container. Consequently, it is possible to customize set design in a simple and practical manner.

All implant modules, both plate and screw modules, are cleaning and sterilization validated, and suitable for machine reprocessing, thus meeting the requirements for optimal reprocessing.

## Implant Storage L1® Midface Configuration 1.5 Midface

### Option 1

#### Plate configuration 1.5 Midface

##### L1® Midface implant storage container – 1.5 Midface, comprised of:

55-990-06-04	Implant container, without modules
55-990-11-04	Plate module 2/3, configured for 1.5 Midface plates in profile thicknesses 0.6 mm and 0.8 mm
55-990-12-04	Plate module 2/3, configured for 1.5 Midface plates in profile thickness 1.0 mm
55-990-20-04	Screw module 2/3, standard screws 1.5 mm dia.
55-990-25-04	Screw module 1/3, emergency and drill-free screws 1.5 mm dia.

##### Optional:

55-990-13-04	Plate module 1/3, configured for 1.5 Smart3D plates in profile thickness 0.6 mm
--------------	---



55-990-06-04  
Implant container  
without modules



55-990-11-04  
Plate module 2/3  
for 1.5 Midface plates  
(profile thicknesses 0.6/0.8 mm)



55-990-12-04  
Plate module 2/3  
for 1.5 Midface plates  
(profile thickness 1.0 mm)



55-990-20-04  
Screw module 2/3  
for standard screws 1.5 mm dia.  
(100 screw single clips)



55-990-25-04  
Screw module 1/3  
for emergency and drill-free  
screws 1.5 mm dia.  
(40 screw single clips)

Configured for:  
Standard screws  
30 x 4 mm  
50 x 5 mm  
10 x 7 mm  
10 x 9 mm

Configured for:  
Emergency screws  
4 x 4 mm  
8 x 5 mm  
8 x 7 mm  
Drill-free screws  
4 x 4 mm  
8 x 5 mm  
8 x 7 mm

##### Optional

55-990-13-04  
Plate module 1/3  
for 1.5 Smart3D plates  
(profile thickness 0.6 mm)







The following 1.5 Midface plates can be stored in the plate module 55-990-11-04		Profile thickness 0.6 mm	Profile thickness 0.8 mm
	Micro-plate 1.5, 4-hole	25-306-04-09	25-308-04-09
	Micro-plate 1.5, 4-hole with bar	25-306-05-09	25-308-05-09
	Micro-plate 1.5, 6-hole	25-306-06-09	25-308-06-09
	Micro-plate 1.5, 24-hole	25-306-24-09	25-308-24-09
	Micro-plate 1.5, 7-hole, L-shape	25-306-07-09	25-308-07-09
	Micro-plate 1.5, 10-hole, L-shape	25-306-09-09	25-308-09-09
	Micro-plate 1.5, 4-hole, cross shape	25-306-14-09	25-308-14-09
	Micro-plate 1.5, 6-hole, double-Y-shape	25-306-16-09	25-308-16-09
	Micro-plate 1.5, 7-hole, Y-shape	25-306-17-09	25-308-17-09
	Micro-plate 1.5, 8-hole, T-shape	25-306-18-09	25-308-18-09
	Micro-mesh 1.5, 6 x 2-hole	25-306-22-09	25-308-22-09
	Micro-plate 1.5, 12-hole, orbita	25-306-32-09	25-308-32-09

The following 1.5 Midface plates can be stored in the plate module 55-990-12-04		Profile thickness 1.0 mm
	Micro-plate 1.5, 4-hole	25-310-04-09
	Micro-plate 1.5, 4-hole with bar	25-310-05-09
	Micro-plate 1.5, 6-hole	25-310-06-09
	Micro-plate 1.5, 24-hole	25-310-24-09
	Micro-plate 1.5, 7-hole, L-shape	25-310-07-09
	Micro-plate 1.5, 10-hole, L-shape	25-310-09-09
	Micro-plate 1.5, 4-hole, cross shape	25-310-14-09
	Micro-plate 1.5, 6-hole, double-Y-shape	25-310-16-09
	Micro-plate 1.5, 7-hole, Y-shape	25-310-17-09
	Micro-plate 1.5, 8-hole, T-shape	25-310-18-09
	Micro-mesh 1.5, 6 x 2-hole	25-310-22-09
	Micro-plate 1.5, 12-hole, orbita	25-310-32-09

## Implant Storage L1® Midface Configuration 1.5 Micro

### Option 2

#### Plate configuration 1.5 Micro

##### L1® Midface implant storage container – 1.5 Micro, comprised of:

55-990-06-04	Implant container, without modules
55-990-10-04	Plate module 2/3, configured for 1.5 micro-plates in profile thickness 0.6 mm
55-990-20-04	Screw module 2/3, standard screws 1.5 mm dia.
55-990-25-04	Screw module 1/3, emergency and drill-free screws 1.5 mm dia.

##### Optional:

55-990-13-04	Plate module 1/3, configured for 1.5 Smart3D plates in profile thickness 0.6 mm
--------------	---



55-990-06-04  
Implant container  
without modules



55-990-10-04  
Plate module 2/3  
for 1.5 Micro-plates  
(profile thickness 0.6 mm)



55-990-20-04  
Screw module 2/3  
for standard screws 1.5 mm dia.  
(100 screw single clips)



55-990-25-04  
Screw module 1/3  
for emergency and drill-free  
screws 1.5 mm dia.  
(40 screw single clips)

Configured for:  
Standard screws  
30 x 4 mm  
50 x 5 mm  
10 x 7 mm  
10 x 9 mm

Configured for:  
Emergency screws  
4 x 4 mm  
8 x 5 mm  
8 x 7 mm  
Drill-free screws  
4 x 4 mm  
8 x 5 mm  
8 x 7 mm

##### Optional

55-990-13-04  
Plate module 1/3  
for 1.5 Smart3D plates  
(profile thickness 0.6 mm)





The following 1.5 micro-plates can be stored in the plate module 55-990-10-04		Profile thickness 0.6 mm
	Micro-plate 1.5, 4-hole, straight	25-304-00-91
	Micro-plate 1.5, 4-hole, straight, short	25-304-55-91
	Micro-plate 1.5, 4-hole, straight, medium	25-304-70-91
	Micro-plate 1.5, 6-hole, straight	25-306-00-91
	Micro-plate 1.5, 6-hole, straight, with bar	25-306-55-91
	Micro-plate 1.5, 16-hole, straight	25-316-00-91
	Micro-plate 1.5, 10-hole, orbita	25-325-10-91
	Micro-plate 1.5, 4-hole, L-shape, left, medium	25-310-70-91
	Micro-plate 1.5, 4-hole, L-shape, left, long	25-310-85-91
	Micro-plate 1.5, 4-hole, L-shape, right, medium	25-311-70-91
	Micro-plate 1.5, 4-hole, L-shape, right, long	25-311-85-91
	Micro-plate 1.5, 7-hole, T-shape	25-330-07-09
	Micro-plate 1.5, 5-hole, Y-shape, medium	25-320-70-91
	Micro-plate 1.5, 6-hole, double-Y-shape, medium	25-322-70-91

## Instrument Storage L1® Midface for Instruments

The instrument storage system is impressive not only because of its easy, well-conceived handling, for example with the instruments arranged according to their sequence of use during the surgical procedure, but also because of its optimized reprocessing capability, in order to equally meet the needs of everyone involved.

The proven concept that has been established at KLS Martin for many years – honeycombed stainless steel combined with high-performance plastic – not only provides high stability at low weight but also results in excellent rinsing.

All the instruments required for an operation can be stored individually next to each other in the storage container. Furthermore, a free storage area offers the option of integrating additional desired instruments.



**55-990-00-04 L1® Midface instrument storage container, comprised of:**

55-990-01-04	Instrument container
55-990-02-04	Orbital insert
55-910-59-04	Lid



55-990-01-04  
Instrument container



55-990-02-04  
Orbital insert



55-910-59-04  
Lid

## Storage **L1®** Midface – the concept for sterile packaged Implants

Apart from the option of conventional storage, the L1® Midface system is also available with sterile packaged implants throughout.

The storage concept for L1® Midface - sterile consists of various components:

The sterile goods trolley is ideal for easy storage, handling, and supply of the sterile packaged implants, both in the operating room and in terms of logistics. The integrated trays can be individually partitioned and thus enable flexible and structured storage as well as a good overview and easy access to the individual items.

In the open-design instrument storage container all the instruments required for an operation can be stored individually.

A special module is available for storage of the sizers, which is of similar design to that for plate storage. Labeling clips with a pictogram and the article number of the plates corresponding to the sizers ensure the right choice of sterile packaged implant.

The sterile packaging allows easy identification of the contents due to the label on the top with all relevant information.



**55-990-00-04 L1® Midface instrument storage container, comprised of:**

55-990-01-04	Instrument container
55-990-02-04	Orbital insert
55-910-59-04	Lid



55-990-01-04  
Instrument container



55-990-02-04  
Orbital insert



55-910-59-04  
Lid

55-990-17-04	Sizer module 2/3, configured for 1.5 Micro-Sizer
55-990-18-04	Sizer module 2/3, configured for 1.5 Midface-Sizer



55-990-17-04  
Sizer module 2/3  
for 1.5 Micro-Sizer



55-990-18-04  
Sizer module 2/3  
for 1.5 Midface-Sizer



55-900-50-04  
Sterile goods trolley incl. 7 containers

**55-900-50-04 Sterile goods trolley, complete, comprised of:**

1 x	Sterile goods trolley with push handle, 66 x 150 x 49 cm (W x H x D)
7 x	Slide-in container, 60 x 10 x 40 cm (W x H x D)
	Horizontal divider, 60 cm, and vertical divider, 40 cm

## KLS Martin Group

### **KLS Martin Australia Pty Ltd.**

Sydney · Australia  
Tel. +61 2 9439 5316  
australia@klsmartin.com

### **KLS Martin do Brasil Ltda.**

São Paulo · Brazil  
Tel. +55 11 3554 2299  
brazil@klsmartin.com

### **KLS Martin Medical (Shanghai) International Trading Co., Ltd**

Shanghai · China  
Tel. +86 21 5820 6251  
info@klsmartin.com

### **KLS Martin India Pvt Ltd.**

Chennai · India  
Tel. +91 44 66 442 300  
india@klsmartin.com

### **KLS Martin Italia S.r.l.**

Milan · Italy  
Tel. +39 039 605 67 31  
info@klsmartin.com

### **KLS Martin Japan K.K.**

Tokyo · Japan  
Tel. +81 3 3814 1431  
info@klsmartin.com

### **KLS Martin SE Asia Sdn. Bhd.**

Penang · Malaysia  
Tel. +604 261 7060  
malaysia@klsmartin.com

### **KLS Martin de México, S.A. de C.V.**

Mexico City · Mexico  
Tel. +52 55 7572 0944  
mexico@klsmartin.com

### **KLS Martin Nederland B.V.**

Huizen · Netherlands  
Tel. +31 35 523 45 38  
infol@klsmartin.com

### **KLS Martin SE & Co. KG**

Moscow · Russia  
Tel. +7 499 792 76 19  
russia@klsmartin.com

### **KLS Martin Taiwan Ltd.**

Taipei · Taiwan  
Tel. +886 2 2325 3169  
taiwan@klsmartin.com

### **KLS Martin SE & Co. KG**

Dubai · United Arab Emirates  
Tel. +971 4 454 16 55  
middleeast@klsmartin.com

### **KLS Martin UK Ltd.**

Reading · United Kingdom  
Tel. +44 118 467 1500  
info.uk@klsmartin.com

### **KLS Martin LP**

Jacksonville · Florida, USA  
Tel. +1 904 641 77 46  
usa@klsmartin.com

### **KLS Martin SE Asia Sdn. Bhd.**

Hanoi · Vietnam  
Tel. +49 7461 706-0  
info@klsmartin.com



### **KLS Martin SE & Co. KG**

#### **A company of the KLS Martin Group**

KLS Martin Platz 1 · 78532 Tuttlingen · Germany  
PO Box 60 · 78501 Tuttlingen · Germany  
Tel. +49 7461 706-0 · Fax +49 7461 706-193  
info@klsmartin.com · www.klsmartin.com